



**SANY**

# SRA550A

ROUGH TERRAIN CRANE



55 USt (50 Mt)



114.8 ft (35 m)



177 ft (53.9 m)

# FULLY LOADED IS THE NEW STANDARD

Best LMI in the Industry

Operator Friendly

Tier 1 Components

Backed by SANY's  
3-Year/3,000-Hour  
Standard Warranty

PRELIMINARY

**WHY SANY ROUGH  
TERRAIN CRANES?**

**STRENGTH.  
RELIABILITY.  
PERFORMANCE.**

SANY's rough terrain cranes have outstanding capacity to perform on a jobsite no matter the challenge or time of day. Operators appreciate the level of simplicity, comfort, high visibility and control at their fingertips. Technicians like the on-board diagnostics system which allows them to address an issue at the source right away so they can have the machine back up and working faster. Less downtime means more work gets done. Like all SANY cranes, they come loaded with all the standard features you need and are backed by the industry's strongest standard warranty. That's 3 years or 3,000 hours of proven reliability.



\*Warranty applies to 2024 Crane models only.



## PROUDLY MADE FOR AMERICA

MODEL  
**SRA550A**

MAX CAPACITY  
**55 USt**

BOOM LENGTH  
**114.8'**

JIB LENGTH  
**30.2' - 52.5'**

MAX TIP HEIGHT  
**177'**

Since 2006, SANY America has been investing in and growing across the U.S. From our 272-acre facility in Georgia, where we employ over 300 American employees, to our growing dealer network that stretches from Maine to Washington, SANY America is dedicated to building business across America. Our industry-leading warranty is proof of SANY's durability. Through our local service network SANY proudly shows continuous support to our machines and the people who operate them.

SANY America is dedicated to helping American-owned businesses thrive with our commitment to value, performance and service.



**SANY's 55 USton rough terrain crane with four-section 114.8-foot full power boom, features strong capacity with reduced self-weight.**





**SRA550A**

# DESIGNED TO **DOMINATE** THE JOBSITE

SANY builds some of the most durable and reliable cranes in the world. That's design validation at the highest level working to increase the overall longevity of your machine. Beyond reliability and durability, we focus on the operator's experience. So we gave the LMI a large, touchscreen monitor which is easier and more intuitive to navigate. Then we focused on spaciousness, visibility, and climate control. This cab will keep them cool in the hottest days of summer and warm in the cold days of winter. They have high visibility of the jobsite day and night with a tiltable cab, wide windows and multiple cameras.

**WE'VE GOT  
YOUR  
BACK**

To provide peace of mind and ensure maximum uptime, SANY backs all its equipment with robust standard warranties. That's our commitment to keeping your fleet running at peak performance. Our network of local dealers will partner with you for routine maintenance and be there for warranty repairs. You can trust SANY to keep you moving, year-round.

**INDUSTRY'S  
STRONGEST  
STANDARD  
WARRANTY** | **3-YEAR  
3,000 HOURS**



## PERFORMANCE

With a long boom, strong winches, and strong charts that are best in their class, we made sure operators have what they need to work at peak performance all day long.

## COMFORT

The roomy, temperature-controlled cabs have intuitive controls and high visibility. They are designed to keep operators comfortable, alert and engaged.

## POWER

Cummins engines, robust and reliable powertrains, and trusted hydraulic components round up the power trifecta.

## CONTROL

From high visibility of the jobsite and controls that are designed to be ergonomic and easy to use to an advanced LMI system that gives them critical information without having to dig through menus, operators have everything they need right in front of them to maintain control of the work and the site.

## STRENGTH

SANY's heavy-duty body, outriggers and counterweight keep the crane stable when the greatest strength and rigidity is needed.

## INDUSTRY-LEADING WARRANTIES

To provide peace of mind and ensure maximum uptime, SANY America's rough terrain cranes are backed by a 3-year/3,000-hour industry-leading standard warranty.

## SUPPORT

SANY's crane dealer network is growing as we seek to provide dealerships across America for local service and maintenance. Including in-house support, parts, and field technicians.

## COMPONENT BRANDS



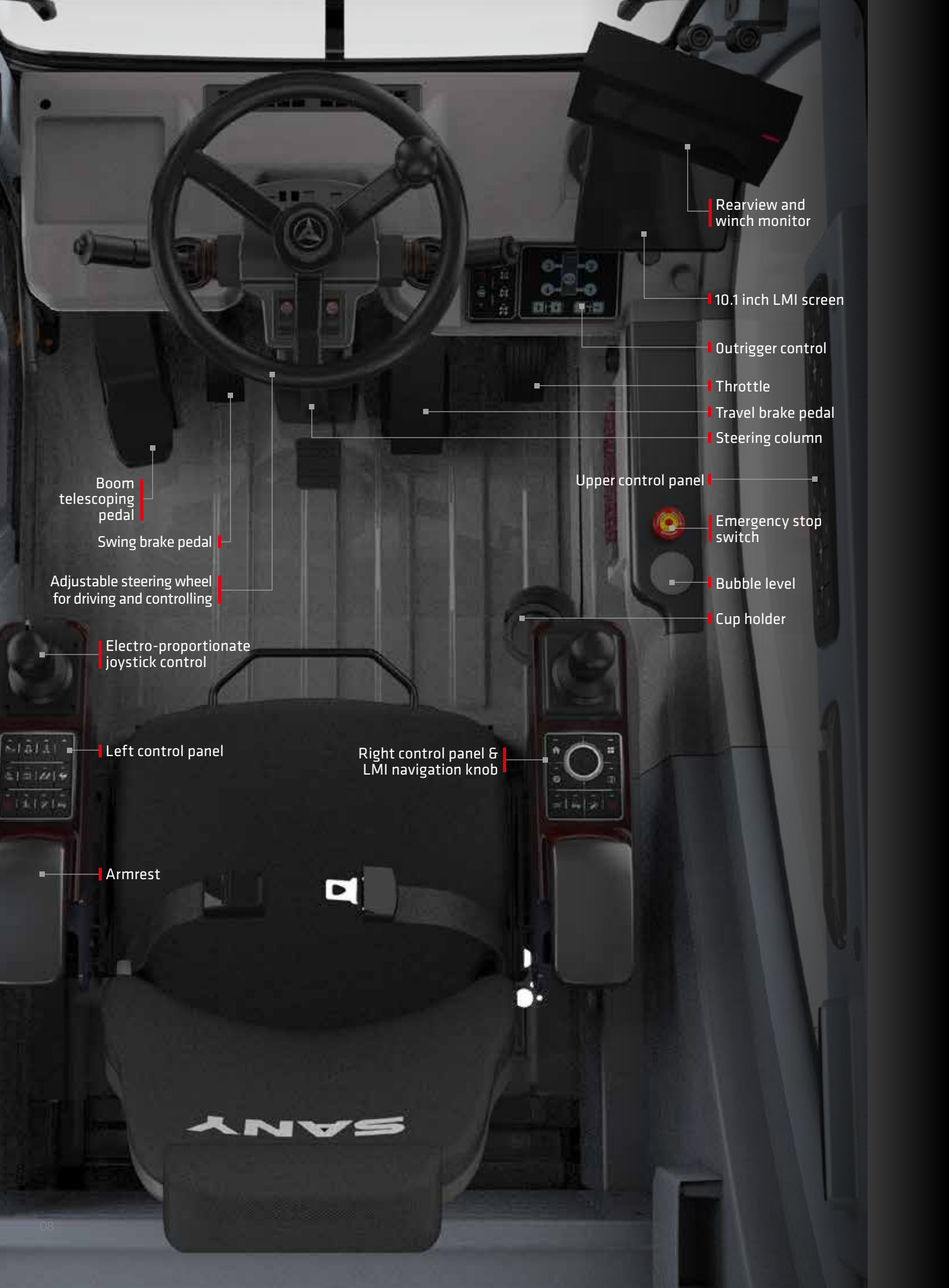

Rearview and winch monitor

10.1 inch LMI screen

Outrigger control

Throttle

Travel brake pedal

Steering column

Upper control panel

Emergency stop switch

Bubble level

Cup holder

Right control panel & LMI navigation knob

Left control panel

Armrest

Electro-proportionate joystick control

Adjustable steering wheel for driving and controlling

Swing brake pedal

Boom telescoping pedal

SANY



# THE SMOOTH, PRECISE CONTROL COMES STANDARD

Inside and out, this cab has been designed to improve the operator experience. The temperature is controlled so operators are always comfortable working throughout the day with enough space to move. Ergonomic, modular and highly efficient controls are well placed. With the use of icons, buttons on the control panels are easy to understand. The controls have good feedback and movement is precise. The LMI in this crane is something SANY is particularly proud of and we think it's the best in the industry—it's unquestionably the most operator-friendly.

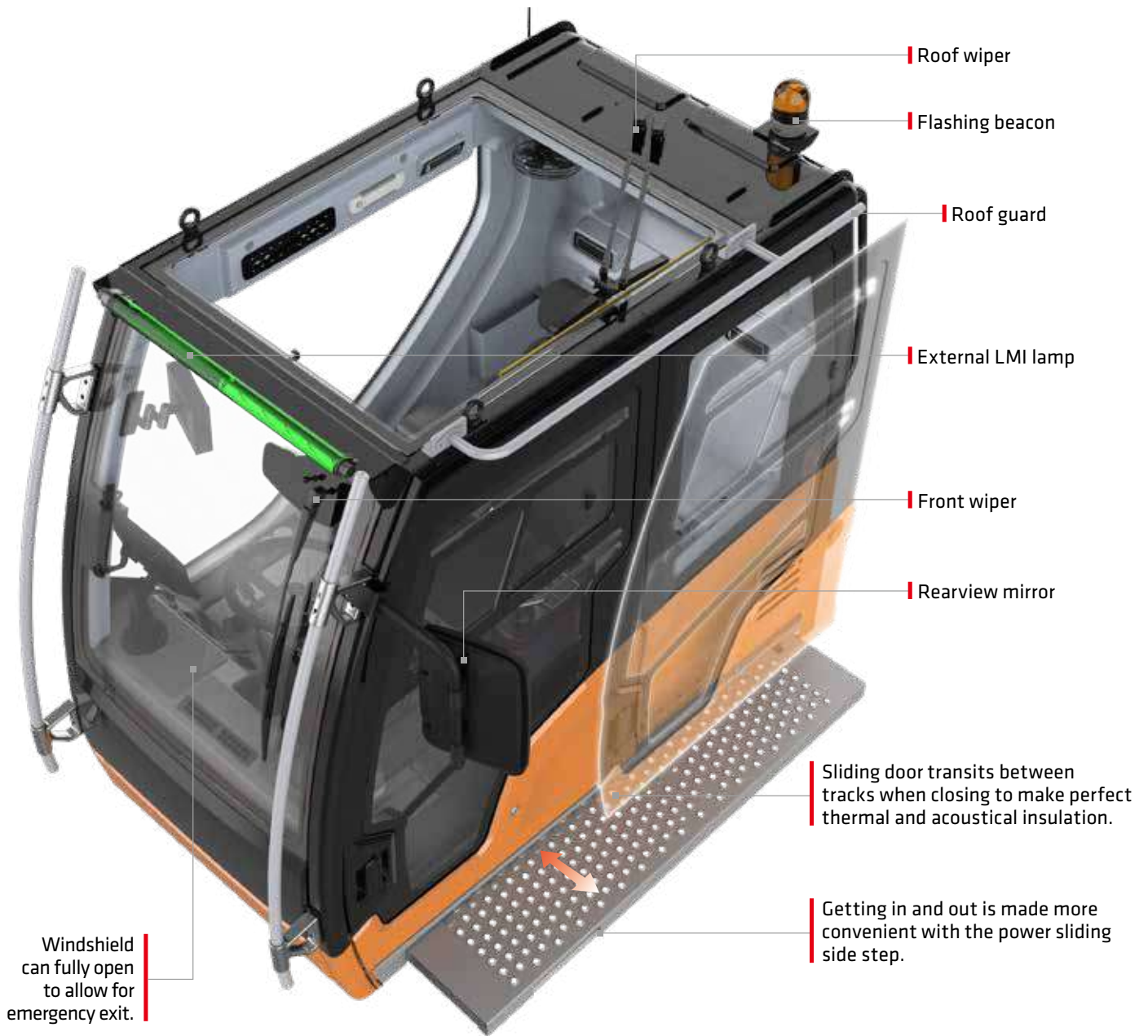

Safety & Reliability



Comfort & Convenience



Simplicity & Efficiency

# THE MOST MODERN & OPERATOR-FRIENDLY LMI IN THE INDUSTRY

## Multi-functional touchscreen

The large 10.1 inch HD touchscreen display incorporates crane setup, working conditions, working period, virtual wall, and diagnostics with an additional navigation knob for convenience.

## Precise Load Moment Indicator (LMI)

SANY's LMI exceeds load accuracy standards.

## More pictorial, less menus

LMI navigation just went to the next level. No need to dig through archaic looking menus trying to find critical information or functionality. No language barriers here, because there's rarely a need for language at all. The LMI is very pictorial which allows operators to easily get to the information they need typically in less than three clicks.

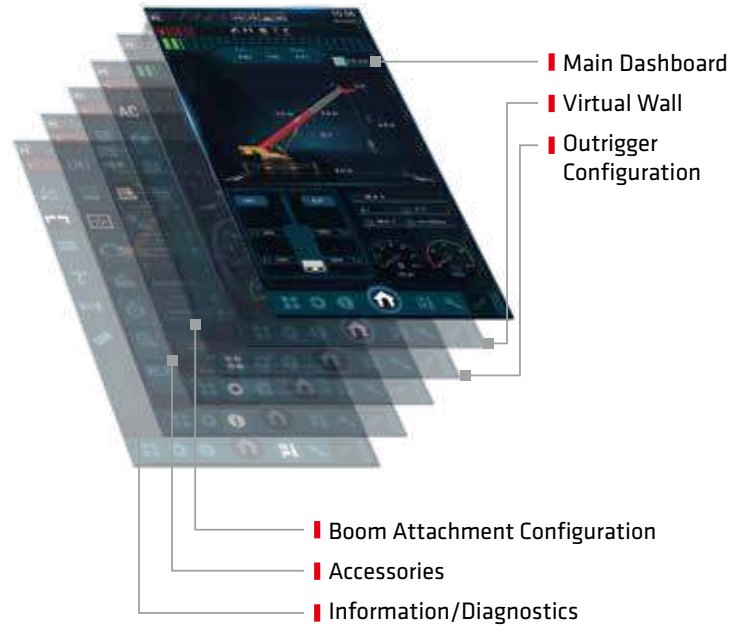

Main Dashboard



Virtual Wall



Outrigger Configuration



## Outstanding screen clarity

Operators have a crisp, clear viewing screen at all times. It's well lit and low glare which makes navigating this LMI even easier any time of day.

Boom Attachment Configuration



Accessories



Information/Diagnostics



## True on-board diagnostics

These advanced diagnostics can even solve an issue down to the wire number. Having critical diagnostic data when you need it means technicians save time problem solving and move right to the solution.

Adjustable steering wheel for driving and controlling, modular control panels, and smart user interface deliver intuitive and highly efficient control.



# HYDRAULIC SYSTEM

The SRA550A has a four section, full power synchronized telescoping boom. The boom extends and retracts by single cylinder with wire rope and pulleys.

## Superstructure

The SRA550A has an open-type electronically controlled load-sensing system and dynamic swing brake system.

With the dynamic swing brake, the crane can realize precise control of the swing speed.

The electro-proportional, compensated, passive luffing-down system is applied to control the luffing speed, making luffing more reliable and stable.

Ensuring easy operation, it has an electronically controlled load-sensing hydraulic system, electronic joystick and electronic throttle.

## Chassis steering system

A gear pump is installed to supply oil for hydraulic steering. The steering pressure is controlled by an electro-proportional relief valve. The four steering modes are controlled by multiple solenoid directional valves.

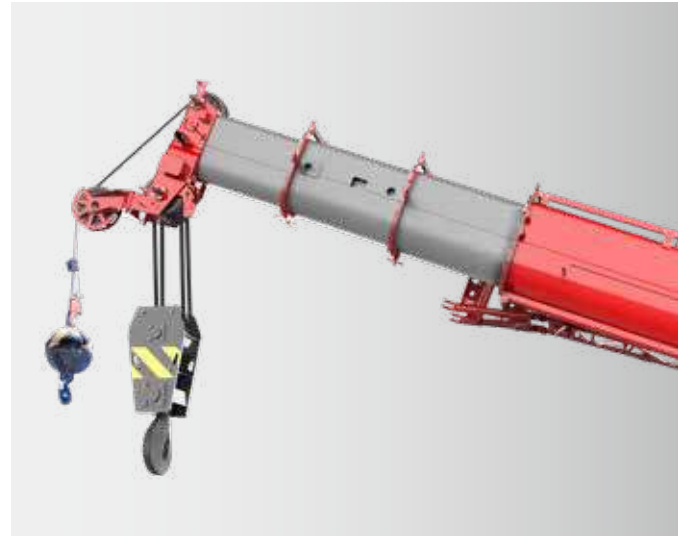

## Outrigger telescoping system

This user friendly system with a single finger control pad has built-in outrigger position sensing with and real time position on the LMI screen. The electro proportional relief valve identifies pressure staging of outrigger telescoping, satisfying operation requirements under high pressure and forming protection under limited pressure.

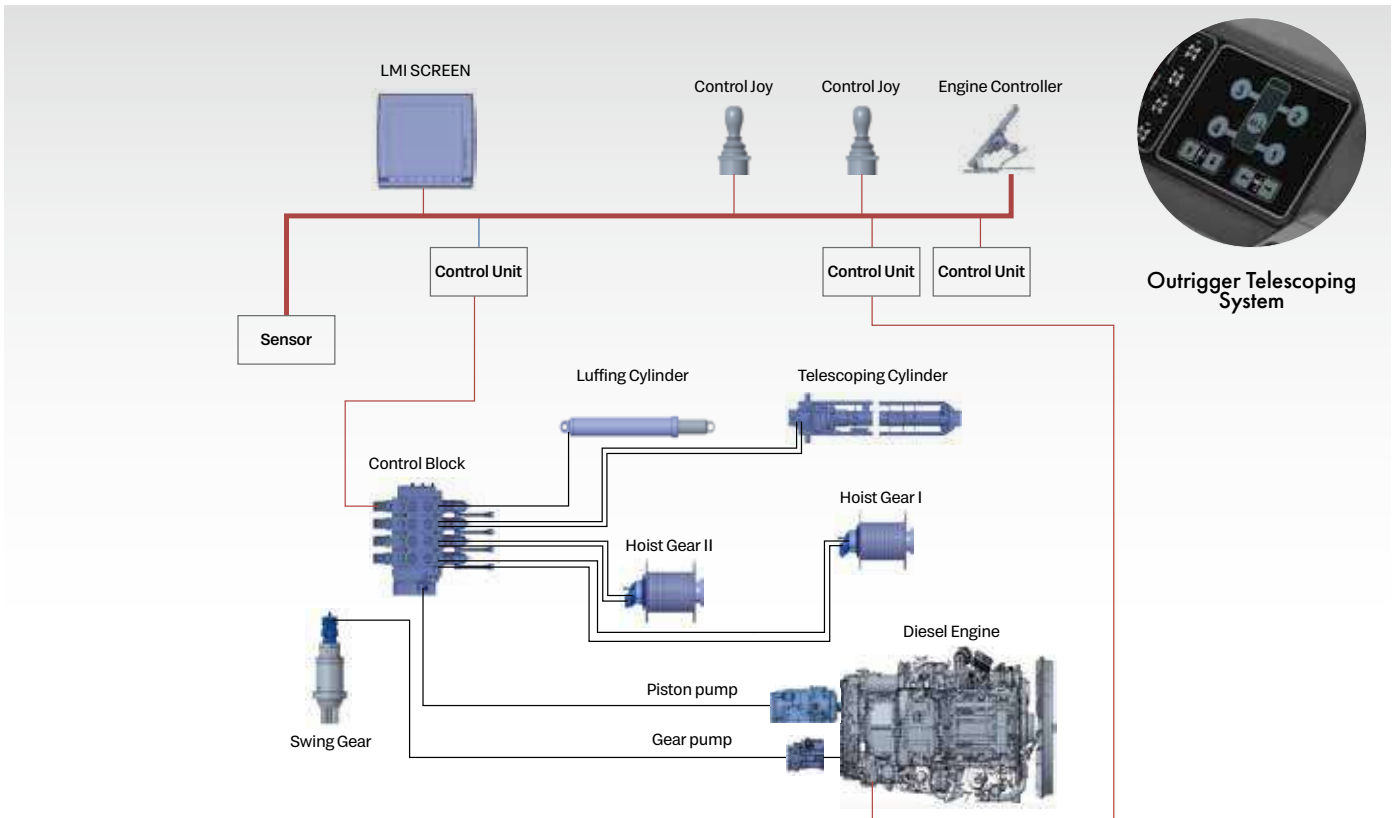

# SYSTEMS, FEATURES & TRUSTED COMPONENTS

The smooth operation and reliability of our cranes is in part due to the seamless design integration of our different component systems. We followed that up with on-board diagnostics to show electrical inputs/outputs, hydraulic pressure readings, and multiple CAN-BUS modules for problem isolation.

## JIB SETUP VIA REMOTE CONTROL



Hydraulic power assisted jib deployment can be handled by one person with the use of remote controller.

The fly jib gives the crane an extra tip height of 177 feet.



- ↑ Pin in
- ↓ Pin out
- ↻ Extension
- ↻ Retraction

Remote controller

# ELECTRICAL SYSTEM

## Smart CAN-BUS communication system

International advanced CAN-BUS data communication network applied for display, instrument panel, I/O module, joysticks and main sensors, allowing for high-speed data transmission and quick response in less than 20ms.

## Cabling

Centralized electric cabinet and heavy-duty connector applied for cabling of superstructure, convenient for maintenance; IP rating up to 67, ensuring high reliability.

## Cameras

Winch cameras equipped for monitoring its working condition, as well as a backup camera and right side swing camera.



Centralized electric cabinet



Anti-two-block limit switch



Third wrap indicator



Cable reel



Anemometer

# CARRIER FRAME



Inverted trapezoidal variable cross section frame is 5% less in weight and 10% stronger in rigidity.

# POWER TRAIN

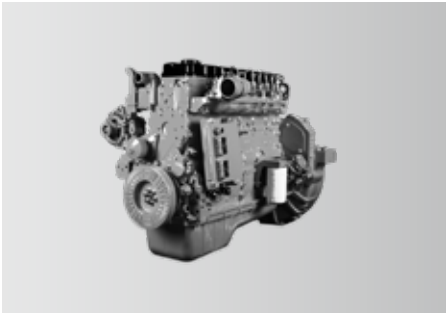

## Engine

Power comes from a Cummins B6.7 inline six-cylinder water-cooled, turbocharged and intercooled off-highway diesel engine, complying with Stage V emission standards.

Rated power: 280 hp/2,200 rpm  
Max. torque: 950 lb-ft/1,500 rpm

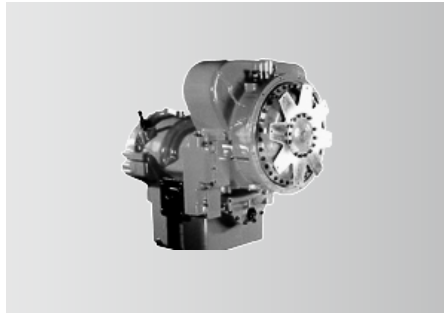

## Transmission

Dana electronically controlled auto transmission features 6 speeds forward and 3 speeds reverse, wide ratio range, and smooth gearshift with reduced maintenance cost.

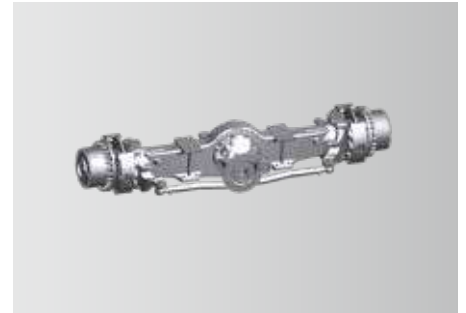

## Axle and suspension

Meritor axles, both axles are driven and steered. Front axle is mounted to the frame by independent steel plate, and rear adopts oscillation cylinders with hydraulic lockout. Driving comfort and lateral stability is therefore guaranteed on rough terrains and conditions.

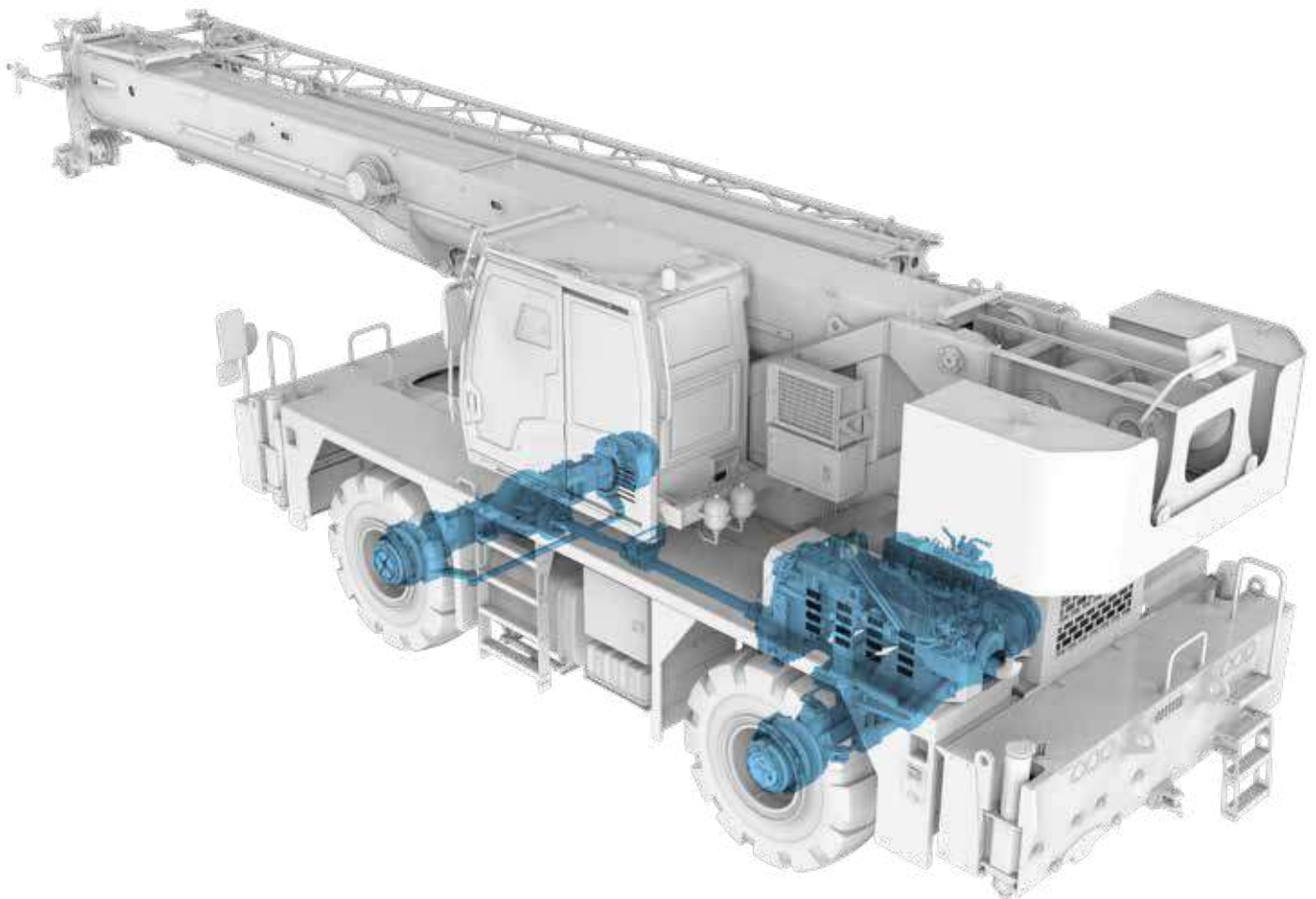

# CONVENIENT TRANSPORT

Four steering modes:

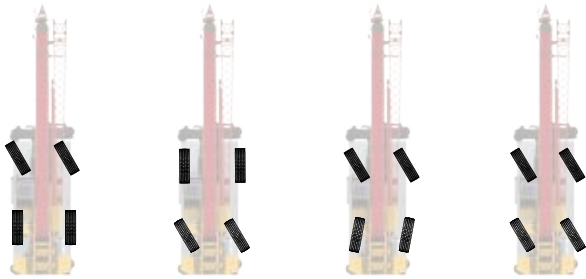

- 2 wheel front
- 2 wheel rear
- 4 wheel
- Crab



Steering control panel

## One-Trailer Transport

Crane fully equipped transports at 79,785 lbs. Overall transport height 12.42 ft, width 9.78 ft.



## Axle Load Distribution

Items	IN POUND			IN KG		
	GVW	Front	Rear	GVW	Front	Rear
Base unit with auxiliary hoist and wire rope	79,785	39,851	39,934	36,190	18,076	18,114
Remark	Base machine, aux. lifting sheave, main & aux. winches with wire ropes, bi-fold fly jib, 35 USt hook block, 5 USt hook ball.					



# TRANSPORT, DIMENSIONS AND TECHNICAL SPECS

The SRA550A's technical specifications and strong load charts fit right in with the 55 USt class in America. They were developed to perform at their peak especially for the American crane operator.

## OVERALL DIMENSIONS

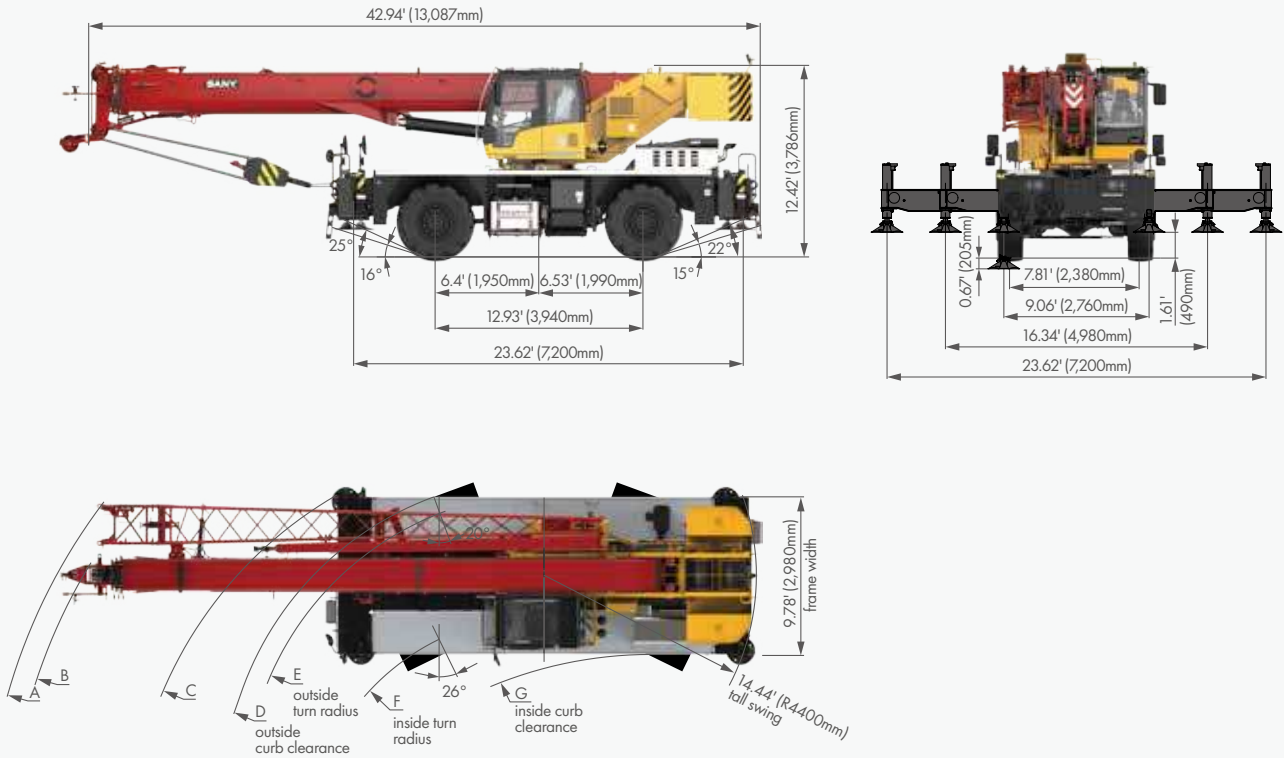

	A	B	C	D	E	F	G
<b>TWO-WHEEL STEER</b>	49.2'	46.9'	40.0'	38.4'	37.7'	29.5'	26.6'
	15.0m	14.3m	12.2m	11.7m	11.5m	9.0m	8.1m
<b>FOUR-WHEEL STEER</b>	35.4'	33.8'	25.3'	19.7'	18.7'	14.4'	13.8'
	10.8m	10.3m	7.7m	6.0m	5.7m	4.4m	4.2m

# TECHNICAL SPECIFICATIONS

CATEGORY	ITEM	UNIT	VALUE	
CAPACITY	Max. lifting capacity	USr (Mt)	55 (50)	
WEIGHT	Gross weight	lbs (kg)	79,785 (36,190)	
POWER	Engine model	Cummins	QSB 6.7 (Stage V)	
	Max. engine power	hp (kW)/rpm	280 (209)/2,200	
	Max. engine torque	lb·ft (N·m)/rpm	950 (1,288)/1,500	
DIMENSIONS	Overall length	ft (mm)	42.94 (13,087)	
	Overall width	ft (mm)	9.78 (2,980)	
	Overall height	ft (mm)	12.42 (3,786)	
TRAVEL	Max.travel speed	mph (km/h)	22.37 (36)	
	Steering radius	Min.steering radius	ft (m)	18.7 (5.7)
		Min.steering radius of boom tip	ft (m)	35.4 (10.8)
	Wheel formula	-	2 wheel /4 wheel	
	Min.ground clearance	ft (mm)	19.7 (500)	
	Approach angle	°	25	
	Departure angle	°	22	
	Max.gradeability	-	88%	
MAIN PERFORMANCE	Working temperature range	°F (°C)	-4~+114.8 (-20~+46)	
	Min.rated lifting radius	ft (m)	8 (2.44)	
	Tail slewing radius	ft (m)	14.44 (4.4)	
	No. of booms	-	4	
	Boom shape	-	U shape	
	Max.lifting moment	Basic boom	lb·ft (kN·m)	1,173,986 (1,591)
		Full-extension boom	lb·ft (kN·m)	769,724 (1,043)
		Full-extension boom+jib	lb·ft (kN·m)	449,376 (609)
	Boom length	Basic boom	ft (m)	35.4 (10.8)
		Full-extension boom	ft (m)	114.8 (35)
		Full-extension boom + jib	ft (m)	167.3 (51)
	Max.tip height	Basic boom	ft (m)	37.7 (11.5)
		Full-extension boom	ft (m)	115.8 (35.3)
		Full-extension boom + jib	ft (m)	177 (53.9)
	Outrigger span (Longitudinal×Transverse)	ft×ft (m×m)	23.6 (7.2)×23.6 (7.2)	
Jib offset	°	0, 20, 40		
Air conditioner	In operator's cab	-	Heating & Cooling	

In the interest of continual equipment development, SANY America Inc. reserves the right to change these specifications at any time without prior notification.

# TECHNICAL PARAMETERS



## Hook

Capacity / USt (Mt)	Number of sheaves	Parts of line	Hook weight /lbs (kg)
60 (55)	3	7	882 (400)
8 (7)	-	1	320 (145)



## Operations

Item	Max. single rope lifting speed (empty load)	Rope diameter/length	Max. single line pull
Main winch	492 ft/min (150 m / min)	0.75" (19 mm) / 623 ft (190 m)	15,500 lbs (7,030 kg)
Auxiliary winch	492 ft/min (150 m / min)	0.75" (19 mm) / 361 ft (110 m)	15,500 lbs (7,030 kg)
Swing speed	2 r / min		
Full luffing up/down time of boom	50 s / 60 s		
Full extension/retraction time of boom	60 s / 65 s		
Outrigger beam	Extension	30 s	
	Retraction	35 s	
Outrigger jack	Extension	20 s	
	Retraction	25 s	



## Hoist Performance

Wire Rope Layer	Hoist Line Pulls		Drum Capacity (ft)	
	Two speed hoist		Layer	Total
	Low	High		
	Available (lb)	Available (lb)		
1	23,900	9,700	131	131
2	21,900	8,900	142	273
3	20,200	8,300	152	425
4	18,800	7,700	162	587
5	17,600	7,200	172	759
6	16,500	6,700	182	941

In the interest of continual equipment development, SANY America Inc. reserves the right to change these specifications at any time without prior notification.

# CRANE INTRODUCTION

## Frame

- Turntable and carrier frame are made of high strength steel, with anti-torsion large cross-section, featuring heavy load-bearing capacity.

## Outrigger

- 4 outriggers, H-type arrangement, controlled by electrically and hydraulically and located at both sides of chassis frame.

## Engine

- Cummins, inline six-cylinder water-cooled compression ignition diesel engine, rated power 280 hp / 2,200 rpm, max. torque 950 lb-ft / 1,500 rpm, off-road Stage V emission standards.
- Fuel tank capacity: Approx. 92.46 gal.

## Hydraulic System

- The constant variable displacement pump is connected to the transmission through PTO for controlling the operation of crane.

## Gearbox

- Automatic transmission from DANA Belgium, with 6 forward and 3 reverse gears available.

## Axles

- With both front axle and rear axle for driving and steering.

## Suspension

- Front axle is connected with frame rigidly; hydraulic suspension is used for rear axle. Road shock is buffered and travel smoothness is improved when driving on roads. The rear suspension cylinder may be locked to rigid state so as to meet the requirement for travel with a load suspended.

## Tires

- 4 tires, each axle is equipped with single tire.
- Tire specifications: 23.5-25.

## Steering

- Four modes: Two wheel front, four wheel, crab, two wheel rear.

## Brakes

- Service brake: dual-circuit hydraulic disc brake, acting on all wheels.
- Parking brake: Front wheels.

## Main Winch System

- Driven by a hydraulic motor, with built-in planetary gear reducer, constantly closed brake and  $\Phi 0.75''$  (19 mm) rotation-resistant wire rope equipped, high speed and low speed mode available.

## Swing System

- Single-row four-point ball contact swing ring, driven by hydraulic motor through planetary gear reducer and with built-in constantly closed brake, for 360° continuous rotation at both directions.

## Boom

- 1 basic boom and 3 telescoping sections, U-shape cross section welding structure. One cylinder with rope pull mechanism for synchronous telescoping.
- 4 sheaves on boom head are standard.
- Boom length: 35.4' (10.8 m)~114.8' (35 m).

## Safety Devices

- Hydraulic balance valve, hydraulic relief valve, hydraulic two-way valve and LMI.
- Third-wrap indicator is equipped for both winches to prevent rope over-releasing. Anti-two block limit switch is fitted on the boom head to prevent rope over-winding.

## Counterweight

- Fixed counterweight, total weight is 9,700 lbs (4.4t).

## Electrical System

- DC 24 volts are in series with two 12-volt battery packs.

## Optional Equipment at Extra Fees

- Spark arrester / Air intake shutoff valve.

# BOOM & JIB COMBINATIONS

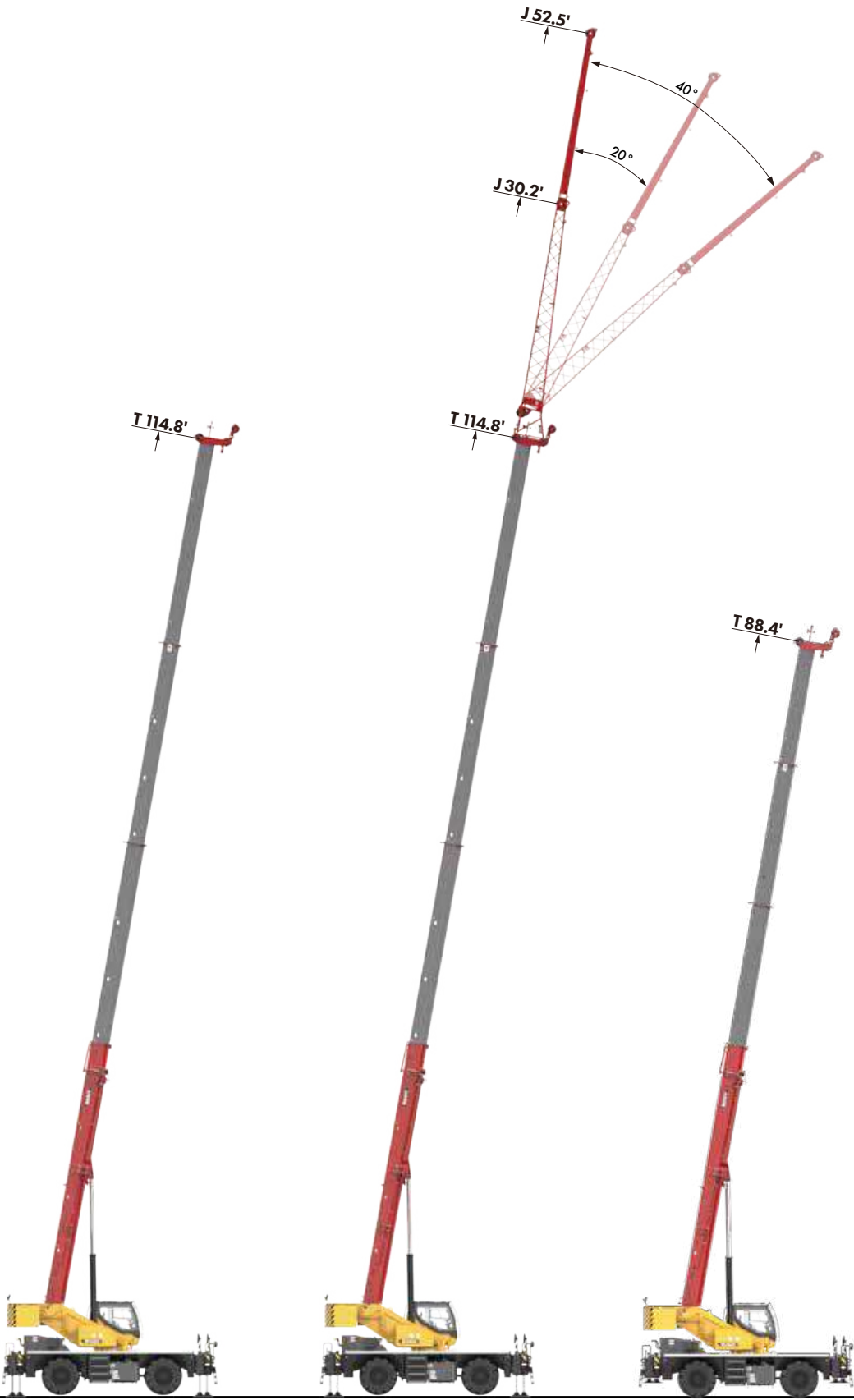

Main Boom On Outriggers

Fly Jib On Outriggers

Main Boom On Tires

# WORKING RANGE DIAGRAM – Main Boom



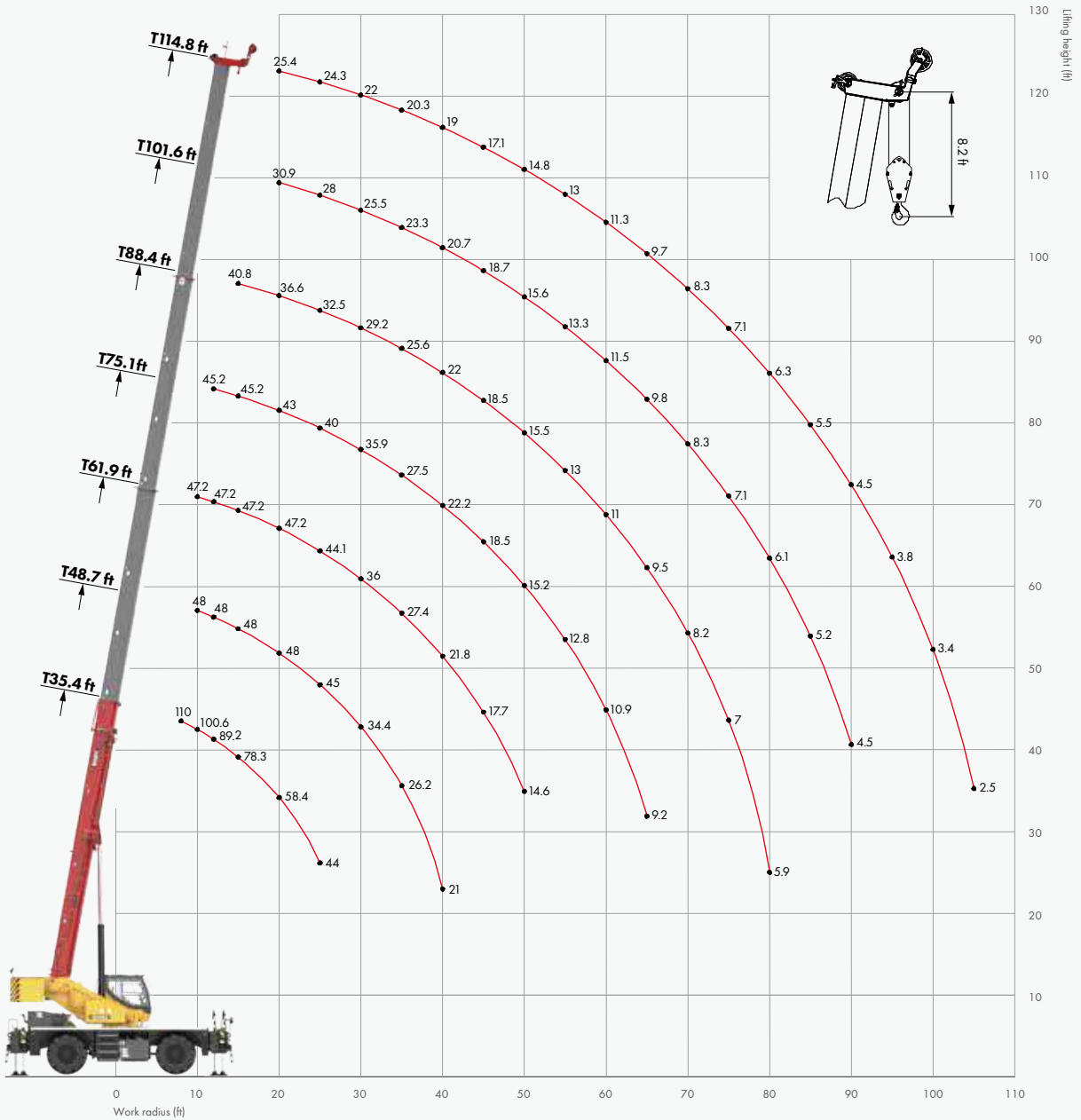



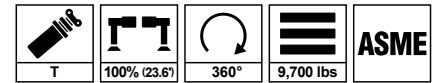









Lifting capacities in klb



# LOAD CHARTS – Main Boom, On 100% Outriggers, 360°









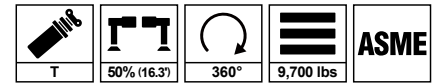











Unit: lbs

 ft	35.4' (10.8 m)	48.7' (14.8m)	61.9' (18.9m)	75.1' (22.9m)	88.4' (26.9m)	101.6' (31.0m)	114.8' (35.0m)	 ft
8	110,000							8
10	100,600	48,000	47,200					10
12	89,200	48,000	47,200	45,200				12
15	78,300	48,000	47,200	45,200	40,800			15
20	58,400	48,000	47,200	43,000	36,600	30,900	25,400	20
25	44,000	45,000	44,100	40,000	32,500	28,000	24,300	25
30		34,400	36,000	35,900	29,200	25,500	22,000	30
35		26,200	27,400	27,500	25,600	23,300	20,300	35
40		21,000	21,800	22,200	22,000	20,700	19,000	40
45			17,700	18,500	18,500	18,700	17,100	45
50			14,600	15,200	15,500	15,600	14,800	50
55				12,800	13,000	13,300	13,000	55
60				10,900	11,000	11,500	11,300	60
65				9,200	9,500	9,800	9,700	65
70					8,200	8,300	8,300	70
75					7,000	7,100	7,100	75
80					5,900	6,100	6,300	80
85						5,200	5,500	85
90						4,500	4,500	90
95							3,800	95
100							3,400	100
105							2,500	105
 2#	0	17	33	50	67	83	100	2# 
 3#	0	17	33	50	67	83	100	3# 
 4#	0	17	33	50	67	83	100	4# 
	8	6	4	4	4	4	4	
 Min	0	0	0	0	0	0	0	 Min
 Min lbs	26,500	16,500	9,900	6,600	4,400	3,300	1,500	 Min lbs
 Max	80	80	80	80	80	80	80	 Max

# LOAD CHARTS – Main Boom, On 50% Outriggers, 360°



Unit: lbs







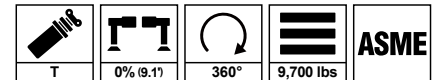





 ft	35.4' (10.8 m)	48.7' (14.8m)	61.9' (18.9m)	75.1' (22.9m)	88.4' (26.9m)	101.6' (31.0m)	114.8' (35.0m)	 ft
8	110,000							8
10	100,600	47,000	46,700					10
12	88,000	47,000	46,700	44,300				12
15	72,600	47,000	46,700	44,300	40,300			15
20	38,700	40,500	42,000	41,400	35,800	30,500	25,100	20
25	24,600	26,500	27,000	27,500	27,500	27,200	23,900	25
30		19,300	19,300	19,700	20,000	19,900	19,600	30
35		14,000	14,700	15,000	15,200	15,600	15,100	35
40		10,800	11,500	12,000	12,100	12,000	12,100	40
45			9,200	9,500	9,800	9,700	9,800	45
50			6,800	7,700	7,900	7,800	8,000	50
55				6,100	6,300	6,300	6,500	55
60				4,800	5,100	5,200	5,300	60
65				3,400	3,800	3,800	4,300	65
70					2,900	2,900	3,500	70
75					2,200	2,300	2,800	75
80						1,600	2,000	80
85							1,300	85
 2#	0	17	33	50	67	83	100	2# 
 3#	0	17	33	50	67	83	100	3# 
 4#	0	17	33	50	67	83	100	4# 
	8	6	4	4	4	4	4	
 Min	0	0	0	0	21	30	35	 Min
 Min 	13,200	6,600	3,300	2,200	1,300	1,100	900	 Min 
 Max	80	80	80	80	80	80	80	 Max



# LOAD CHARTS – Main Boom, On 0% Outriggers, 360°



Unit: lbs

 ft	35.4' (10.8 m)	48.7' (14.8m)	61.9' (18.9m)	75.1' (22.9m)	88.4' (26.9m)	101.6' (31.0m)	114.8' (35.0m)	 ft
8	76,000							8
10	49,000	46,700	46,000					10
12	35,000	36,400	36,200	35,700				12
15	23,400	24,500	25,200	25,100	24,300			15
20	13,500	14,700	15,200	15,800	15,400	14,900	14,300	20
25	8,500	9,600	10,100	10,600	10,800	10,400	9,900	25
30		6,300	6,600	7,300	7,500	7,300	7,100	30
35		4,100	4,500	5,000	5,200	5,200	4,800	35
40			3,000	3,500	3,700	3,700	3,500	40
45			2,000	2,400	2,600	2,700	2,500	45
50				1,400	1,500	1,600	1,500	50
 2#	0	17	33	50	67	83	100	2# 
 3#	0	17	33	50	67	83	100	3# 
 4#	0	17	33	50	67	83	100	4# 
 C <sub>n</sub>	6	6	4	4	4	4	4	 C <sub>n</sub>
 Min	0	30	33	40	49	55	59	 Min
 Min lbs	3,300	2,200	1,300	1,100	1,100	1,100	1,100	 Min lbs
 Max	72	76	78	80	80	80	80	 Max

**Remark**

1. Load capacity in the chart is the maximum weight which this crane could hoist include the hook block's weight. The hook block weighs 882 lbs (400 kg), the overhaul ball weighs 320 lbs (145 kg).
2. Radius shown in the chart is the actual radius when loading.
3. The load capacity in the chart is the maximum weight when this crane is supported with the firm ground and stays in level.
4. Choose rated load capacity of the longer boom and radius when the actual boom length and radius are between two values in the charts.
5. The machine can be used only when the wind scale is less than 6.







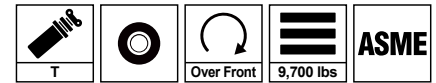









Operator must refer to in-cab load chart manual for crane operation.

In the interest of continual equipment development, SANY America Inc. reserves the right to change these specifications at any time without prior notification.

# LOAD CHARTS – Main Boom, Stationary, On Tires, Over Front Tires









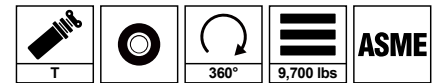









Unit: lbs

 ft	35.4' (10.8 m)	48.7' (14.8m)	61.9' (18.9m)	75.1' (22.9m)	88.4' (26.9m)	 ft
10	37,000					10
12	32,000	32,500				12
15	26,000	26,500	27,000			15
20	18,400	19,500	20,400	20,500		20
25	12,300	13,500	14,200	14,500	14,800	25
30		9,700	10,300	10,500	10,800	30
35		7,000	7,800	8,000	8,300	35
40		5,000	5,800	6,000	6,400	40
45			4,300	4,500	5,000	45
50			3,200	3,500	3,800	50
55				2,600	2,900	55
60				1,900	2,100	60
65					1,500	65
 2#	0	17	33	50	67	2# 
 3#	0	17	33	50	67	3# 
 4#	0	17	33	50	67	4# 
	4	4	4	4	4	
 Min	0	0	0	26	35	 Min
 lbs	6,600	2,600	1,300	1,300	1,100	 lbs
 Max	80	80	80	80	80	 Max

# LOAD CHARTS – Main Boom, Stationary, On Tires, 360°









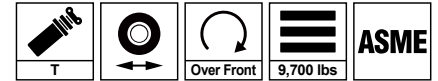



Unit: lbs

 ft	35.4' (10.8 m)	48.7' (14.8m)	61.9' (18.9m)	75.1' (22.9m)	88.4' (26.9m)	 ft
10	22,500					10
12	18,500	19,500				12
15	15,000	15,300	15,700			15
20	8,800	10,500	11,200	11,500		20
25	5,500	6,400	7,200	7,400	7,800	25
30		4,300	4,500	4,700	5,000	30
35		2,800	3,000	3,200	3,500	35
40			1,800	2,000	2,200	40
 2#	0	17	33	50	67	2# 
 3#	0	17	33	50	67	3# 
 4#	0	17	33	50	67	4# 
	4	4	4	4	4	
 Min	0	0	40	51	57	 Min
 lbs	2,200	1,100	1,100	1,100	1,100	 lbs
 Max	66	72	74	77	78	 Max

# LOAD CHARTS – Main Boom, Pick & Carry, On Tires, Over Front Tires



Unit: lbs

 ft	35.4' (10.8 m)	48.7' (14.8m)	61.9' (18.9m)	75.1' (22.9m)	88.4' (26.9m)	 ft	
10	24,000					10	
12	20,700	21,300				12	
15	16,900	17,500	17,800			15	
20	12,500	13,100	13,500	13,700		20	
25	9,500	10,200	10,500	10,800	10,900	25	
30		8,000	8,400	8,600	8,700	30	
35		6,200	6,700	6,800	7,200	35	
40		4,500	5,100	5,400	5,600	40	
45			3,800	4,100	4,300	45	
50			2,800	3,100	3,300	50	
55				2,300	2,500	55	
60				1,700	1,900	60	
 %	2#	0	17	33	50	67	2#
	3#	0	17	33	50	67	3#
	4#	0	17	33	50	67	4#
	4	4	4	4	4	4	
	0	0	0	26	40	0	
	4,400	2,200	1,100	1,100	1,100	1,100	
	80	80	80	80	80	80	

**Remark**

1. Capacities are applicable at 69 psi (476 kpa) cold tire inflation pressure.
2. Capacities are applicable only with machine on firm level surface.
3. On tire lifting with the jib mounted is not permitted.
4. Axle lockouts must be applied when lifting on tires.
5. Parking brake must be applied when lifting on tires stationary.
6. Driving speed shall be less than 2.49 mph (4km/h) at pick & carry mode.

Operator must refer to in-cab load chart manual for crane operation.

In the interest of continual equipment development, SANY America Inc. reserves the right to change these specifications at any time without prior notification.

# WORK RANGE DIAGRAM – Fly Jib

Lifting capacities in klb

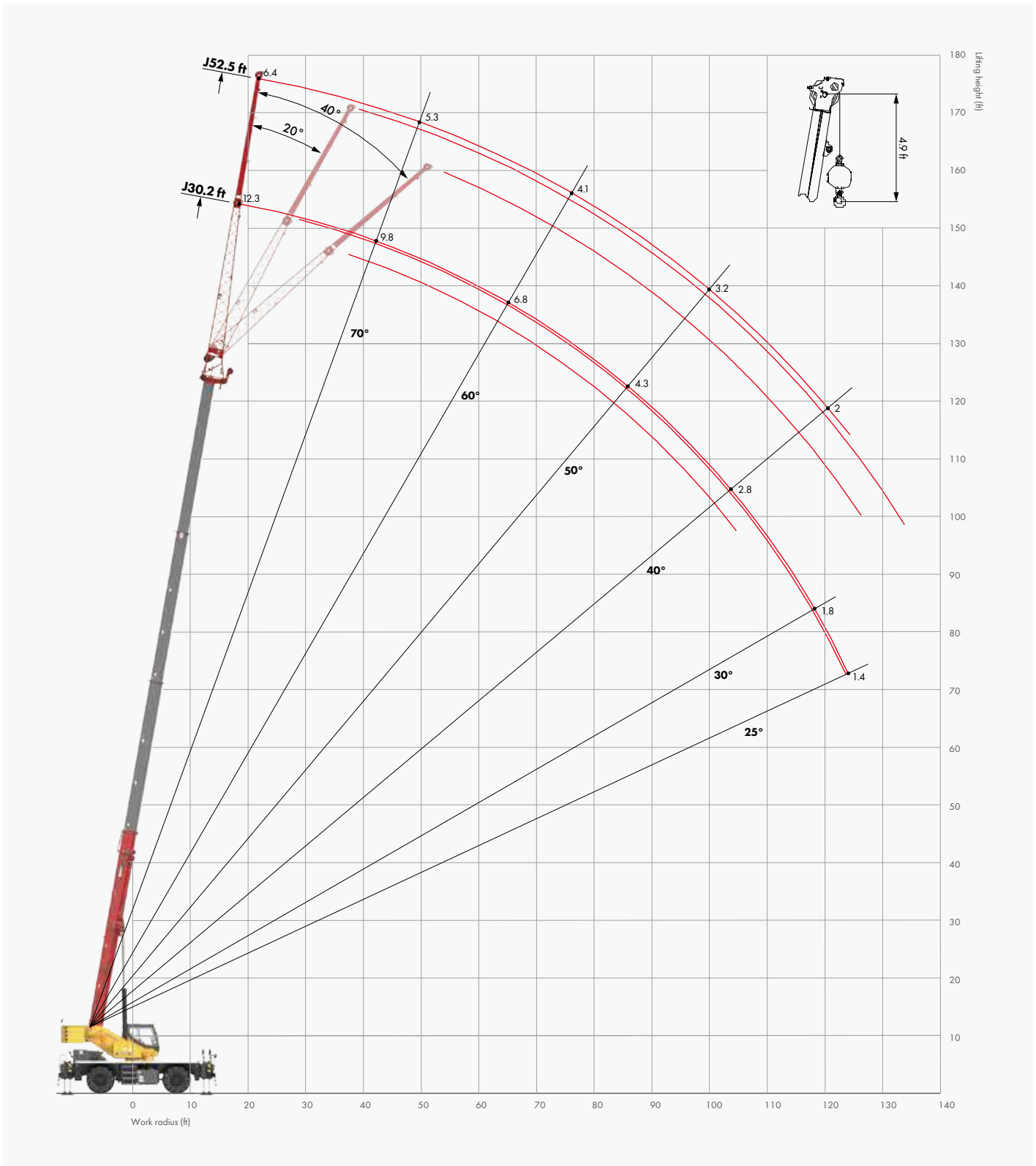

# LOAD CHARTS – Fly Jib

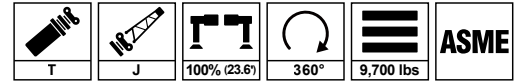

Unit: lbs

ft 180°	114.8' (35m) boom + 30.2' (9.2m) jib						114.8' (35m) boom + 52.5' (16m) jib						ft 180°
	0°		20°		40°		0°		20°		40°		
	ft	lbs	ft	lbs	ft	lbs	ft	lbs	ft	lbs	ft	lbs	
80	20.0	12,300	30.5	8,400	37.7	6,000	24.3	6,400	41.3	4,100	55.1	2,800	80
78	24.8	12,000	34.5	8,000	41.7	5,900	30.5	6,300	46.8	4,000	59.9	2,700	78
76	29.7	11,800	39.2	7,800	46.3	5,800	36.7	6,200	52.2	3,900	64.6	2,700	76
74	35.1	11,200	44.5	7,500	50.7	5,600	42.8	6,000	57.6	3,700	69.7	2,600	74
72	40.7	10,300	50.5	7,200	55.8	5,500	48.9	5,600	63.0	3,500	74.8	2,500	72
70	46.0	9,800	55.1	7,100	60.1	5,400	54.8	5,300	68.6	3,400	79.9	2,500	70
68	51.2	9,100	59.7	6,900	64.3	5,300	60.7	5,000	74.1	3,300	85.0	2,500	68
66	56.1	8,500	64.3	6,600	68.9	5,200	66.0	4,800	79.2	3,200	89.4	2,400	66
64	61.0	7,900	68.9	6,400	73.5	5,100	71.2	4,500	84.3	3,100	93.8	2,400	64
62	65.1	7,400	73.5	6,200	77.6	5,050	76.8	4,300	89.3	3,000	98.1	2,400	62
60	69.2	6,800	78.1	5,800	81.7	5,000	82.3	4,100	94.2	2,900	102.4	2,300	60
58	73.7	6,300	81.9	5,400	85.3	4,900	87.3	3,900	98.8	2,800	106.3	2,200	58
56	78.1	5,900	85.6	5,100	88.9	4,700	92.2	3,700	103.3	2,700	110.2	2,200	56
54	82.2	5,300	89.2	4,800	92.5	4,400	96.8	3,600	107.4	2,600	113.7	2,200	54
52	86.3	4,900	92.8	4,400	96.1	4,000	101.4	3,300	111.5	2,500	117.1	2,200	52
50	90.1	4,300	96.1	4,100	99.3	3,800	105.7	3,200	115.5	2,400	120.6	2,100	50
48	93.8	3,900	99.4	3,700	102.4	3,400	109.9	2,900	119.4	2,200	124.0	2,000	48
46	97.3	3,600	102.9	3,400	105.0	3,200	113.9	2,700	122.9	2,100	127.0	1,900	46
44	100.7	3,200	106.3	3,100			118.0	2,400	126.3	2,000			44
42	104.0	3,000	109.1	2,800			122.0	2,100	129.6	1,800			42
40	107.3	2,800	111.9	2,600			125.5	2,000	132.9	1,700			40
38	110.3	2,600	114.5	2,300			129.2	1,600	135.8	1,500			38
36	113.2	2,400	117.1	2,200			132.5	1,400	138.7	1,300			36
35	114.5	2,300	118.2	2,100			134.2	1,200	140.1	1,100			35
34	115.7	2,200	119.4	2,000									34
32	118.4	2,000	121.7	1,800									32
30	120.9	1,800	124.0	1,700									30
28	123.4	1,600	126.3	1,500									28
26	124.9	1,500	127.5	1,400									26
25	126.3	1,400	128.6	1,300									25
	1												
	24		24		45		34		34		45		
	700		400		2,200		900		700		1,100		

**Remark**

1. The capacities listed are with the outriggers fully extended and vertical jacks properly set only.
2. The fly jib may only be used for single line lifting service.
3. Use only the load which corresponds to the boom extension length and offset angle as the machine is configured.
4. For boom angles not shown, use the rating of the next lower boom angle.
5. The boom angle is defined as the angle above or below the horizontal line of the longitudinal axis of the boom base section after lifting the rated load.
6. When lifting over the main boom nose with the fly jib erected, the outriggers must be fully extended and the proper load reduction must be used.
7. Do not lower the boom below the minimum boom angle with the jib erected. Fully retract the boom to lower the boom below the minimum boom angle.

Operator must refer to in-cab load chart manual for crane operation.

In the interest of continual equipment development, SANY America Inc. reserves the right to change these specifications at any time without prior notification.



# SANY

**INDUSTRY'S  
STRONGEST  
STANDARD  
WARRANTY** **3-YEAR  
3,000 HOURS**

\*Warranty applies to 2024 Crane models only.

**SANY America Inc.**  
**318 SANY Way**  
**Peachtree City | GA 30269**  
**| T | 470-552-SANY**

**BRCRA245RA550A001**

**sanyamerica.com**

In the interest of continual equipment development, SANY America Inc. reserves the right to change these specifications at any time without prior notification.

© 2024 SANY AMERICA INC.

